

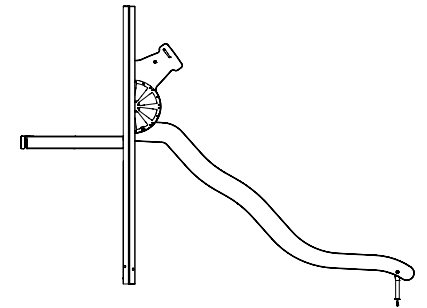





















**OM**



BOM ID	IMAGE	QUANTITY	DESCRIPTION	DOCUMENT ID	WEIGHT
1		1		32-04155	2.0
2		1		21-01601	46.38
3		1		32-03127	2.17
4		1		43-05006	0.28
5		1		SW45583	6.36
6		1		SW45592	6.36
7		1		SW54346	3.19
8		1		SW54350	3.19
9		4	M6	43-04810	0.00
10		4	M6	43-04811	0.00
11		6	M8	43-04813	0.00

BOM ID	IMAGE	QUANTITY	DESCRIPTION	DOCUMENT ID	WEIGHT
12		6	M8	43-04816	0.00
13		4	M10	43-04818	0.01
14		2	M10	43-04820	0.00
15		4	8x21,4x4,5	43-07119	0.00
16		2	M10x86 HDG	8008561	0.04
17		4	Fujilok-M6-8-RingA2	8008794	0.002
18		4	Fujilok-M8-8-RingA2	8008795	0.006
19		2	ISO4014-M8x40-8.8	8008349	0.0218
20		2	ISO4017-M10x25-8.8	8008371	0.0263
21		2	ISO4017-M8x55-8.8	8008354	0.0277
22		4	ISO8677-M6x25-8.8	8008566	0.009

23		2	ISO8677-M8x45-8.8	8051445	0.025
24		4	M6x25-8.8-(ISO7380)	8027762	0.007
25		4	TKFT-6x40-8.8	8008651	0.01
26		4	TKFT-8x60-8.8	8008646	0.02
27		4	11x24x2-ISO4759-3-C	8008850	0.006
28		4	6.4x14x1.6-ISO4759-3-C	8008848	0.002
29		8	9x18x2-ISO4759-3-C	8008849	0.003

