

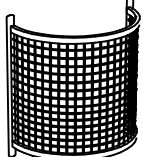



TYPE	HAGS.NO
	8045152
0,33x0,71x0,76m	
	8066231
0,36x0,67m	

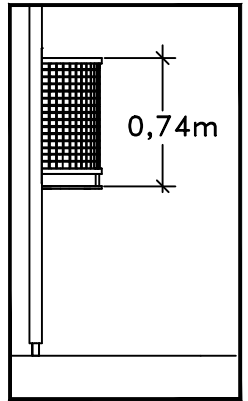
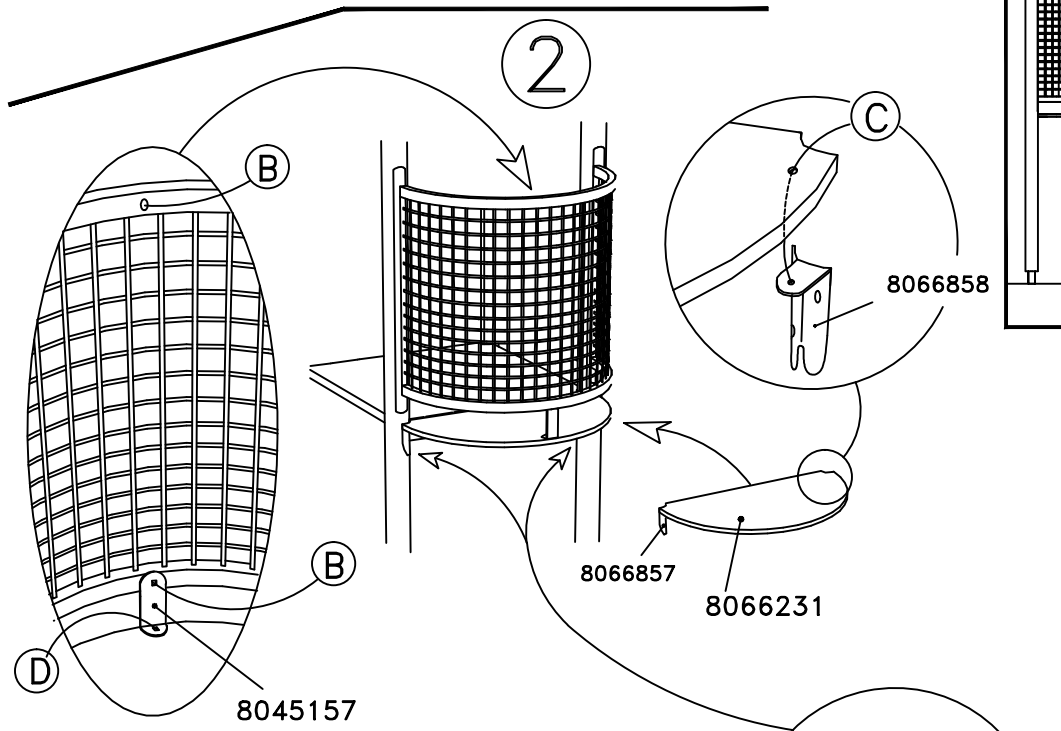
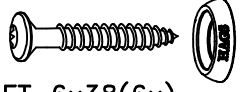
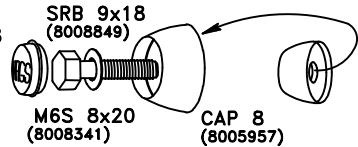
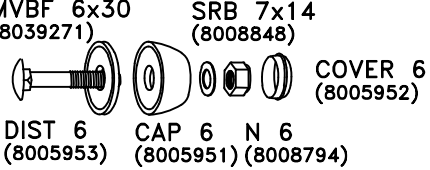
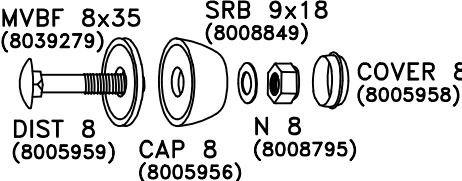

A		15/7x3(6x) (8035290)
		TKFT 6x38(6x) (8008651)
B		COVER 8 (8005958)
		SRB 9x18 (8008849)
		MGS 8x20 (8008341)
		CAP 8 (8005957)
C		MVBF 6x30 (8039271)
		SRB 7x14 (8008848)
		COVER 6 (8005952)
		DIST 6 (8005953)
		CAP 6 N 6 (8005951) (8008794)
D		MVBF 8x35 (8039279)
		SRB 9x18 (8008849)
		COVER 8 (8005958)
		DIST 8 (8005959)
		CAP 8 N 8 (8008795) (8005956)

HAGS ANEBY, SWEDEN
+46(0)380-47300
www.hags.com

Balcony
692213

 SSV  ToB 2017-10-19 | 2